

WX-LOK

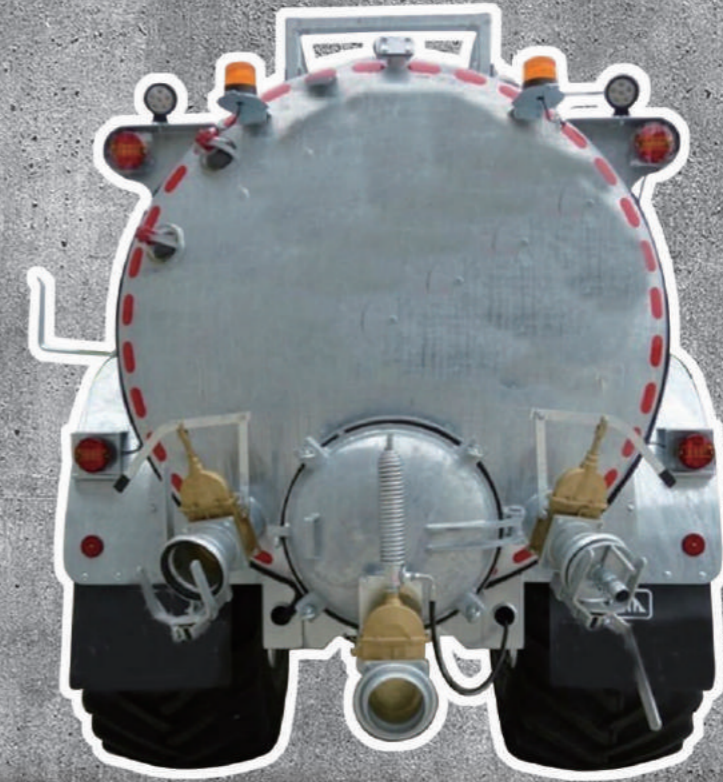

ZHE JIANG WAYSING METAL PRODUCTS CO.,LTD

WX-LOK

Hoses, Couplings & Solutions
Sewage transmission & Irrigation system





Brief introduction

ZheJiang WAYSING Metal Products Co.,Ltd. specializes in the producing of hose coupling. We can provide the hose coupling in aluminum, brass and stainless steel. The product is produced strictly according with the F1122、 A-A-59326 American standard or DIN2828 Germany standard,etc.

The company has the capability of self-development, mold design, gravity casting, forging and aluminum-alloy T6 heat treatment. We set up the whole process for product produce, quality control and so on. We have established friendly business relationship with clients throughout the world such as clients in Uk、 USA、 Australia. Etc.

We put all of our effort to produce the "world best hose coupling" with the highest quality and competitive price by means of continue development. With our strong technical background, we also can produce the product base on the clients' design and requirement. We sincerely welcome all friends from home and abroad for long-term cooperation.

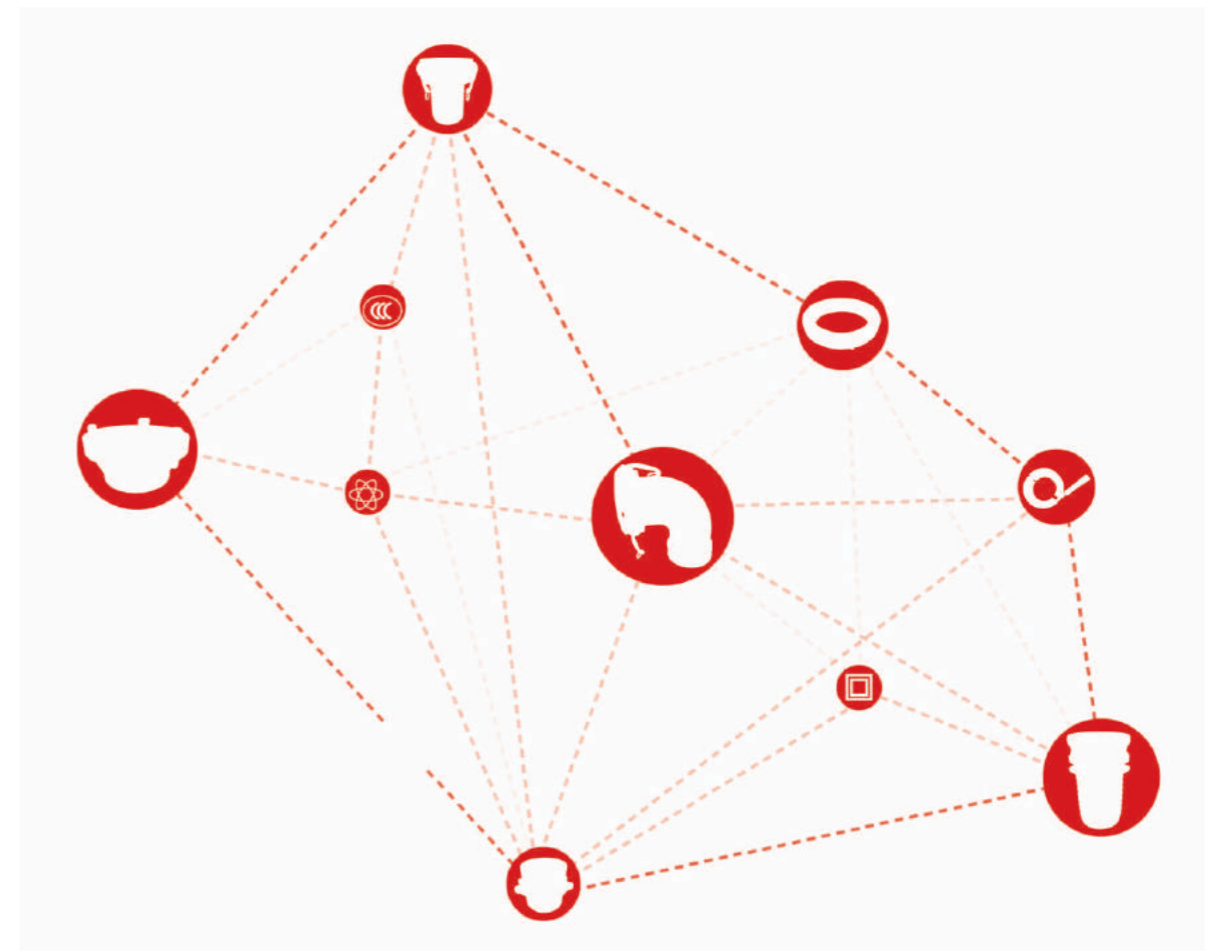

Drag Hose coupling



Part No.	Size
DHCS-400-AL	4"
DHCS-450-AL	4-1/2"
DHCS-500-AL	5"
DHCS-550-AL	5-1/2"
DHCS-600-AL	6"
DHCS-700-AL	7"
DHCS-800-AL	8"
DHCS-1000-AL	10"

STORZ Coupling



Part No.	Size
ST400-AL	4"
ST500-AL	5"
ST600-AL	6"

Part No.	Size
ST800-AL	8"
ST1000-AL	10"
ST-1200-AL	12"

Drag Hose Coupling-Hose Mender



Part No.	Size
DHMS-400-AL	4"
DHMS-450-AL	4-1/2"
DHMS-500-AL	5"
DHMS-550-AL	5-1/2"
DHMS-600-AL	6"
DHMS-700-AL	7"
DHMS-800-AL	8"
DHMS-1000-AL	10"

Ring Lock Fittings



Part No.	Size
RLW-300	3"
RLW-400	4"
RLW-500	5"
RLW-600	6"
RLW-800	8"
RLW-1000	10"
RLW-1200	12"

Large Diameter Grooved Hose Coupling Set (without Victaulic clamp) Hard Anodizing



Part No.	Size
LDHC-400-AL	4"
LDHC-600-AL	6"
LDHC-800-AL	8"
LDHC-1000-AL	10"
LDHC-1200-AL	12"

Ringlock Push-in Type Full Set



Part No.	Size
RLP-300	3"
RLP-400	4"
RLP-500	5"
RLP-600	6"
RLP-800	8"
RLP-1000	10"
RLP-1200	12"

Large Diameter Grooved Hose Mender Full Set



Part No.	Size
LDHM400-AL	4"
LDHM600-AL	6"
LDHM800-AL	8"
LDHM1000-AL	10"
LDHM1200-AL	12"

Ringlock Barb Hose Shank Type Male End



Part No.	Size
RLBM-300	3"
RLBM-400	4"
RLBM-500	5"
RLBM-600	6"
RLBM-800	8"
RLBM-1000	10"
RLBM-1200	12"

Ringlock Barb Hose Shank Type Male End



Part No.	Size
RLWO-300	3"
RLWO-400	4"
RLWO-500	5"
RLWO-600	6"
RLWO-800	8"

LINE TEE



Part No.	Size
RLET-400	4"
RLET-500	5"
RLET-600	6"
RLET-800	8"

Ringlock Barb Hose Shank Type Male End



Part No.	Size
RLWO-300-AL	3"
RLWO-400-AL	4"
RLWO-500-AL	5"
RLWO-600-AL	6"
RLWO-800-AL	8"

Standard Sytle Bauer Coupling-Full Set



Part No.	Size	Description
BAUER-200	2"	2" Crimping Sytle Bauer coupling
BAUER-300	3"	3" Crimping Sytle Bauer coupling
BAUER-400	4"	4" Crimping Sytle Bauer coupling
BAUER-500	5"	5" Crimping Sytle Bauer coupling
BAUER-600	6"	6" Crimping Sytle Bauer coupling
BAUER-800	8"	8" Crimping Sytle Bauer coupling
BAUER-1000	10"	10" Crimping Sytle Bauer coupling



END CAP



Part No.	Size
RLEC-300	3"
RLEC-400	4"
RLEC-500	5"
RLEC-600	6"
RLEC-800	8"

END PLUG



Part No.	Size
RLEP-300	3"
RLEP-400	4"
RLEP-500	5"
RLEP-600	6"
RLEP-800	8"

Standard Sytle Bauer Coupling-Full Set



Part No.	Size	Description
BAUER-200-KC	2"	2" Crimping Sytle Bauer coupling
BAUER-300-KC	3"	3" Crimping Sytle Bauer coupling
BAUER-400-KC	4"	4" Crimping Sytle Bauer coupling
BAUER-500-KC	5"	5" Crimping Sytle Bauer coupling
BAUER-600-KC	6"	6" Crimping Sytle Bauer coupling
BAUER-800-KC	8"	8" Crimping Sytle Bauer coupling
BAUER-1000-KC	10"	10" Crimping Sytle Bauer coupling



SAFETY INLINE VAC RELIEF VALVE



Part No.	Size
RLRV-400	4"
RLRV-500	5"
RLRV-600	6"
RLRV-800	8"

LINE TEE



Part No.	Size
RLLT-400	4"
RLLT-500	5"
RLLT-600	6"
RLLT-800	8"

Miller Coupling Full Set-M Type



Part No.	Size	Description
MTC-600	6"	6" Miller Coupling
MTC-800	8"	8" Miller Coupling
MTC-1000	10"	10" Miller Coupling
MTC-1200	12"	12" Miller Coupling

Aluminum Bauer Coupling



Part No.	Size	Description
BAUER-400-AL	4"	4" Aluminum Bauer Coupling
BAUER-600-AL	6"	6" Aluminum Bauer Coupling
BAUER-800-AL	8"	8" Aluminum Bauer Coupling
BAUER-1000-AL	10"	10" Aluminum Bauer Coupling

Miller Coupling Full Set-M Type



Part No.	Size	Description
PTC-200	2"	2" Perrot Coupling
PTC-300	3"	3" Perrot Coupling
PTC-350	3-1/2"	3-1/2" Perrot Coupling
PTC-400	4"	4" Perrot Coupling
PTC-600	6"	6" Perrot Coupling

Storz Coupling Hose Shank



Part No.	Size
SCHS-100	1"
SCHS-200A	2"
SCHS-200B	2"
SCHS-2050	2-1/2"
SCHS-300A	3"
SCHS-300B	3"
SCHS-400	4"

Storz Female



Part No.	Size
STF-100	1"
STF-200	2"
STF-250	2-1/2"
STF-300	3"
STF-400	4"

Storz Male



Part No.	Size
STM-100	1"
STM-200	2"
STM-250	2-1/2"
STM-300	3"
STM-400	4"

Storz Cap



Part No.	Size
STCAP-100	1"
STCAP-200	2"
STCAP-250	2-1/2"
STCAP-300	3"
STCAP-400	4"

Storz Reduced Size



Part No.	Size
St2010	2"X1"
ST2520	2-1/2"X2"
ST3020	3"X2"
ST3025	3"X2-1/2"
ST4030	4"X3"

Male Adapter Female Thread



TYPE A

Part No.	Size
A-050-AL	1/2"
A-075-AL	3/4"
A-100-AL	1"
A-125-AL	1-1/4"
A-150-AL	1-1/2"
A-200-AL	2"
A-250-AL	2-1/2"
A-300-AL	3"
A-400-AL	4"
A-500-AL	5"
A-600-AL	6"
A-800-AL	8"

Female coupler male thread



Part No.	Size
B-050-AL	1/2"
B-075-AL	3/4"
B-100-AL	1"
B-125-AL	1-1/4"
B-150-AL	1-1/2"
B-200-AL	2"
B-250-AL	2-1/2"
B-300-AL	3"
B-400-AL	4"
B-500-AL	5"
B-600-AL	6"
B-800-AL	8"

TYPE B

Female coupler hose shank



Part No.	Size
C-050-AL	1/2"
C-075-AL	3/4"
C-100-AL	1"
C-125-AL	1-1/4"
C-150-AL	1-1/2"
C-200-AL	2"
C-250-AL	2-1/2"
C-300-AL	3"
C-400-AL	4"
C-500-AL	5"
C-600-AL	6"
C-800-AL	8"

TYPE C

Dust Plug



Part No.	Size
DP-050-AL	1/2"
DP-075-AL	3/4"
DP-100-AL	1"
DP-125-AL	1-1/4"
DP-150-AL	1-1/2"
DP-200-AL	2"
DP-250-AL	2-1/2"
DP-300-AL	3"
DP-400-AL	4"
DP-500-AL	5"
DP-600-AL	6"
DP-800-AL	8"

TYPE DP

Female coupler hose shank



Part No.	Size
E-075-ALMS	3/4"
E-100-ALMS	1"
E-125-ALMS	1-1/4"
E-150-ALMS	1-1/2"
E-200-ALMS	2"
E-250-ALMS	2-1/2"
E-300-ALMS	3"
E-400-ALMS	4"
E-500-ALMS	5"
E-600-ALMS	6"
E-800-ALMS	8"

TYPE C

Female coupler female thread



Part No.	Size
D-050-AL	1/2"
D-075-AL	3/4"
D-100-AL	1"
D-125-AL	1-1/4"
D-150-AL	1-1/2"
D-200-AL	2"
D-250-AL	2-1/2"
D-300-AL	3"
D-400-AL	4"
D-500-AL	5"
D-600-AL	6"
D-800-AL	8"

Male adapter hose shank



Part No.	Size
E-050-AL	1/2"
E-075-AL	3/4"
E-100-AL	1"
E-125-AL	1-1/4"
E-150-AL	1-1/2"
E-200-AL	2"
E-250-AL	2-1/2"
E-300-AL	3"
E-400-AL	4"
E-500-AL	5"
E-600-AL	6"
E-800-AL	8"

Male adapter hose shank



Part No.	Size
F-075-ALMS	3/4"
F-100-ALMS	1"
F-125-ALMS	1-1/4"
F-150-ALMS	1-1/2"
F-200-ALMS	2"
F-250-ALMS	2-1/2"
F-300-ALMS	3"
F-400-ALMS	4"
F-500-ALMS	5"
F-600-ALMS	6"
F-800-ALMS	8"

TYPE E

Female coupler x male adapter



Part No.	Size
DA 1510AL	1.5"Fx1"M
DA 1520AL	1.5"Fx2"M
DA 2015AL	2"Fx1.5"M
DA 2030AL	2"Fx3"M
DA 2040AL	2"Fx4"M
DA 3015AL	3"Fx1.5"M
DA 3020AL	3"Fx2"M
DA 3040AL	3"Fx4"M
DA 4020AL	4"Fx2"M
DA 4030AL	4"Fx3"M
DA 4060AL	4"Fx6"M
DA 6040AL	6"Fx4"M

Type DA

Male adapter male thread



Part No.	Size
F-050-AL	1/2"
F-075-AL	3/4"
F-100-AL	1"
F-125-AL	1-1/4"
F-150-AL	1-1/2"
F-200-AL	2"
F-250-AL	2-1/2"
F-300-AL	3"
F-400-AL	4"
F-500-AL	5"
F-600-AL	6"
F-800-AL	8"

TYPE F

Dust cap



Part No.	Size
DC-050-AL	1/2"
DC-075-AL	3/4"
DC-100-AL	1"
DC-125-AL	1-1/4"
DC-150-AL	1-1/2"
DC-200-AL	2"
DC-250-AL	2-1/2"
DC-300-AL	3"
DC-400-AL	4"
DC-500-AL	5"
DC-600-AL	6"
DC-800-AL	8"

TYPE DC

90° Coupling DA



Part No.	Size
DA200-AL	90°2"
DA300-AL	90°3"
DA400-AL	90°4"
DA500-AL	90°5"
DA600-AL	90°6"

45° Coupling DA



Part No.	Size
DA200-AL	45°2"
DA300-AL	45°3"
DA400-AL	45°4"
DA500-AL	45°5"
DA600-AL	45°6"

King Nipple



Part No.	Size
KC-050	1/2"
KC-075	3/4"
KC-100	1"
KC-125	1-1/4"
KC-150	1-1/2"
KC-200	2"
KC-250	2-1/2"
KC-300	3"
KC-400	4"
KC-500	5"
KC-600	6"
KC-800	8"
KC-1000	10"

Sleeve



Part No.	Sleeve ID
310S30P	3-9/16"
415S40P	4-14/16"
700S60P	6-14/16"
706S60P	7"
904S80P	7-1/16"

Bauer Type Coupling With Strainer



Part No.	Size
BTC200-ST	2"
BTC300-ST	3"
BTC400-ST	4"
BTC600-ST	6"
BTC800-ST	8"

Ferrule



Part No.	Sleeve ID
310F30P	3-9/16"
415F40P	4-14/16"
700F60P	6-14/16"
706F60P	7"
904F80P	7-1/16"

Double Bolt



Part No.	Size
SL	

Bauer Female 6" Red-to



Part No.	Size
BRC1-200	2"
BRC1-300	3"
BRC1-400	4"

6" Female Hose End



Part No.	Size
BRC2-600	6"

Spiral Hose Clamp



Part No.	Size
SHC	

T-bolt



Part No.	Size
TPL	

6" Male Hose End



Part No.	Size
BRC3-600	6"

6" Male Quick Attach Assembly



Part No.	Size
BRC4-600	6"

Punch Clamp



Part No.	Size
CP	

Gear Clamp



Part No.	Size
GC	

6" Female Quick Attach Assembly



Part No.	Size
BRC5-600	6"

Bauer Female



Part No.	Size
BRC6-400	4"
BRC6-500	5"
BRC6-600	6"

Italian Male



Part No.	Size
BRC7-400	4"
BRC7-500	5"
BRC7-600	6"

Italian Male 6" Red-to



Part No.	Size
BRC8-400	2"
BRC8-500	3"
BRC8-600	4"

Bauer Type Coupling With Flange



Part No.	Size
BTC200-FL	2"
BTC300-FL	3"
BTC400-FL	4"
BTC600-FL	6"
BTC800-FL	8"

Italian Male 6" Red- to



Part No.	Size
BRC9-400	2"
BRC9-500	3"
BRC9-600	4"

Italian Male



Part No.	Size
BRC10-300	3"
BRC10-400	4"
BRC10-500	5"

Bauer Coupling Male Ball With Flange(150 ASA) -B Type



Part No.	Size
BTCMF-200	2"
BTCMF-300	3"
BTCMF-400	4"
BTCMF-500	5"
BTCMF-600	6"
BTCMF-800	8"

Italian Female Quick Attach Assembly



Part No.	Size
BRC11-300	3"
BRC11-400	4"
BRC11-500	5"

Hose Joiner



Part No.	Size
HJC1-400	4"
HJC1-500	5"

Bauer Coupling Female Ball With Flange(150 ASA) -B Type



Part No.	Size
BTCFF-200	2"
BTCFF-300	3"
BTCFF-400	4"
BTCFF-500	5"
BTCFF-600	6"
BTCFF-800	8"

Hose Joiner



Part No.	Size
HJC2-300	3"
HJC2-400	4"
HJC2-500	5"
HJC2-600	6"

Bauer Type Coupling With Male Thread



Part No.	Size
BTC200-M	2"
BTC300-M	3"
BTC350-M	3-1/2"
BTC400-M	4"
BTC600-M	6"
BTC800-M	8"

Gate Valve Fittings: Female End with 4 Bolt Flange



Part No.	Size
SC1-600	6"

Gate Valve Fittings: Male End with 4 Bolt Flange



Part No.	Size
SC2-600	6"

4 Hole Flange



Part No.	Size
SC3-400	4"
SC3-500	5"

6" Female Sprinkler 90° with Cone



Part No.	Size
SC10-600	6"

6" Male Sprinkler 90° with Cone



Part No.	Size
SC11-600	6"

Male&Female 90° Coupling



Part No.	Size
SC4-600	6"

Male&Female 90° Coupling



Part No.	Size
SC5-600	6"

6" Male & Female 90° Bend



Part No.	Size
SC12-600	6"

6" Female Assembly



Part No.	Size
SC13-600	6"

Male 90° with Cone



Part No.	Size
SC6-600	6"

Steel Pipe 90° Bend



Part No.	Size
SC7-600	6"

6" Female Precision Assembly



Part No.	Size
SC14-600	6"

6" Male Precision Assembly



Part No.	Size
SC15-600	6"

Threaded Steel Tube



Part No.	Size
SC8-600	6"

6" Male 70° Assembly



Part No.	Size
SC9-600	6"

6" Female Assembly



Part No.	Size
SC16-600	6"

6" Male Precision Assembly



Part No.	Size
SC17-600	6"

6" Female Assembly



Part No.	Size
SC18-6006"	

Pressure Gauge



Part No.	Size
PG2502	1/2"
PG400	4"
PG4504	1/2"

Strainer



Part No.	Size
RHS150	2"
RHS200	3"
RHS250	2-1/2"
RHS300	3"
RHS400	4"
RHS600	6"
RHS800	8"

Non-Screw Sight Glass



Part No.	Size
NSSG500-AL	5"
NSSG500-FE	5"
NSSG500-SS	5"

Screw Sight Glass



Part No.	Size
SSG200-FE	2"
SSG300-FE	3"

Manhole



Part No.	Size
MH001	

Screw Sight Glass



Part No.	Size
WN001-FE	
WN002-SS	

Gearbox



Part No.	Size
GB4090	

Docking Funnel



Part No.	Size
DF-600	6"
DF-800	8"
DF-1000	10"

Tool Box



Part No.	Size
Tb001	

Sponge Clean Out Ball



Part No.	Size
WN001-FE	
WN002-SS	

Floating Rubber Ball



Part No.	Size
FRB60-160mm	
FRB70-170mm	
FRB80-180mm	
FRB100-1100mm	

Floating Stainless Steel Ball



Part No.	Size
RB60-260mm	
FRB70-270mm	
FRB80-280mm	
FRB100-2100mm	

Butterfly Valve Wafer Type



Part No.	Size
BFVL300	3"
BFVL400	4"
BFVL600	6"
BFVL800	8"
BFVL1000	10"
BFVL1200	12"

Butterfly Valve Wafer Type



Part No.	Size
BFVW300	3"
BFVW400	4"
BFVW600	6"
BFVW800	8"
BFVW1000	10"
BFVW1200	12"

Brass Vacuum Relief Valve



Part No.	Size
VRVL150	1-1/2"
VRVLC150	

Brass Pressure Relief Valve



Part No.	Size
PRVL125	1-1/4"
PRVL150	1-1/2"
PRVL200	2"
PRVLR	

sprinkler gun

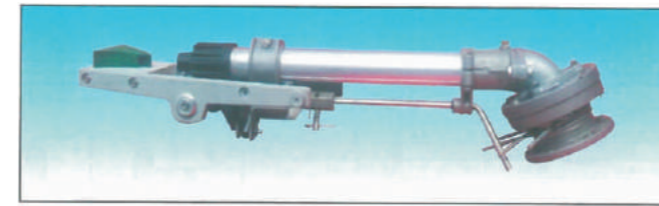

22° General style



22° Lengthen style



44° General style



44° Lengthen style

Brass Lever Gate Valve



Part No.	Size
GV200	2"
GV300	3"
GV400	4"
GV600	6"

Brass Lever Gate Valve- Flange×NPT



Part No.	Size
GV400	4"
GV600	6"

Sprinkler parts



Part No.	Size
SP001	2"

Sprinkler parts



Part No.	Size
Sp002	2"

Brass Piston Valve NPT×NPT



Part No.	Size
BPV400	4"
BPV400-A	4"
BPV400-H	4"
BPV600-M	6"
BPV600-A	6"
BPV600-NH	6"

4Bolt Flange Brass Piston Valve



Part No.	Size
BFPV400	4"
BFPV400-A	4"
BFPV400-H	4"
BFPV600	6"
BFPV600-A	6"
BFPV600-H	6"
BFPV800	8"

Sprinkler parts



Part No.	Size
SP003	2"

Sprinkler parts



Part No.	Size
SP004	1.5"

Brass Ball Valve



Part No.	Size
BBV050	1/2"
BBV075	3/4"
BBV100	1"
BBV125	1-1/4"
BBV150	1-1/2"
BBV200	2"
BBV300	3"
BBV400	4"

Brass Bolted Ball Valve



Part No.	Size
BBBV400	4"

Sprinkler parts



Part No.	Size
SP005	Ø12 Ø30

Sprinkler parts



Part No.	Size
Sp006	2" 2.5"

Sprinkler parts



Part No.	Size
SP007	2" 4"

Sprinkler parts



Part No.	Size
Sp008	2" 2.5"

Sprinkler parts



Part No.	Size
SP009	

Sprinkler parts



Part No.	Size
SP010	

Sprinkler parts



Part No.	Size
SP011	2.5" 3"

Sprinkler parts



Part No.	Size
SP012	2" 2.5"

Sprinkler parts



Part No.	Size
SP013	2" 2.5" 3"

Sprinkler parts



Part No.	Size
SP014	2" 2.5" 3"

Application:

one type of through-the-weave polyurethane (PU/TPU) covered hose. Manureflow Drag hoses shall be made from 100% high tenacity synthetic yarn circular woven and completely, totally embedded in the PU compound, excellent protected against mechanical damage, forming a single homogenous construction without the use of any glues or adhesives of any type. Thick and smooth cover and super adhesion between layers ensure a long life span for drag hoses



Tube:PU/TPU

Reinforcement:Circular woven polyester jacket

Cover:Smooth PU cover and tube

Temperature:(-)-60°F to (+)176°F

Lengths:660ft/200m;990ft/300m, 1320ft/400m, other lengths available per request

Technoogy

Part.No	Size	Hosel.D.(mm)	W.P.	BurstPressur	WallThickness(mm)
PUDRH190103	4"	103+2.0	190	560	3.6
PUDRH190128	5"	128+2.5	190	560	4
PUDRH150141	5.5"	141+2.5	150	450	4
PUDRH150153	6"	153+2.5	150	450	4.2
PUDRH135178	7"	178+3.0	135	405	4.4

Application:

Designed for Suction , discharge or gravity flow of water ,salt water and oily water in construction , agriculture mining or equipment rental . Green PVC, flexible.



Tube:PVC

Reinforcement:PVC Helix

Cover:weather,ozone and UV resistant

Temperature:(-)14°F to (+)150°F

Lengths:lengths available per request

Technoogy

Part.No	Size	Hosel.D.(mm)	W.P.	BurstPressure	WallThickness(mm)
PVCHH 10019	3/4"	19.05	100		5.08
PVCHH 10025	1"	25.4	100		5.59
PVCHH 10031	1-1/4"	31.75	100		4.06
PVCHH 10038	1-1/2"	38.1	100		6.86
PVCHH 10050	2"	50.8	100		8.13
PVCHH 8063	2-1/2"	63.5	80		9.4
PVCHH 7576	3"	76.2	75		8.89
PVCHH 60101	4"	101.6	60		12.45
PVCHH 50152	6"	152.5	50		11.58

Application:

Septic,waste water and liquid manure handing; agricultural liquid fertilizers and standard duty water suction,as well as suction and transfer for rental construction and trash pump.

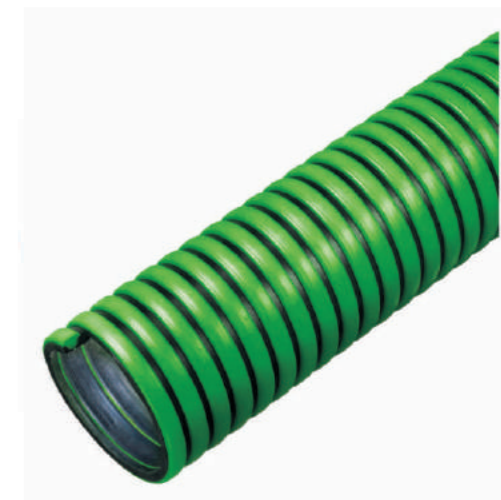

Tube:EPDM

Reinforcement:EPDM tube with polyethylene clockwise helix

Cover:

Temperature:(-)40°F to (+)140°F

Lengths:lengths available per request

Technoogy

Part.No	Size	Hosel.D.(mm)	W.P.	BurstPressure	WallThickness(mm)
PVCHH 10019	1-1/2"	38.1	50		8.89
PVCHH 10025	2"	50.8	50		10.92
PVCHH 10031	3"	76.2	45		13.21
PVCHH 10038	4"	101.6	38		15.24

SEPTIC & WASTEWATER

Designed for general water discharge in construction, agriculture and irrigation. Blue PVC, flexible, reinforcement is knitted polyester yarn. Temperature range -14°F to +150°F.

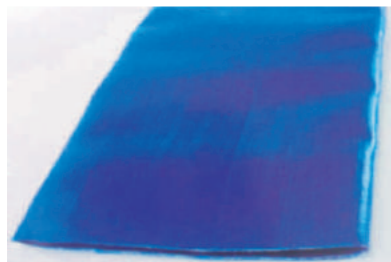

Inner Diameter (inch/mm)	Wall thickness (inch/mm)	Working Pressure
1" 25	0.06 1.5	4bar
1-1/2" 38	0.06 1.5	4bar
2" 50.8	0.06 1.6	4bar
2-1/2" 65	0.06 1.6	4bar
3" 76	0.06 1.6	4bar
4" 102	0.07 1.7	4bar
6" 150	0.07 1.7	3bar

Designed for general water discharge in construction, agriculture and heavy duty euqipment rental.Red PVC, reinforcement is knitted polyester yarn. Temperature range -14°F to +150°F.

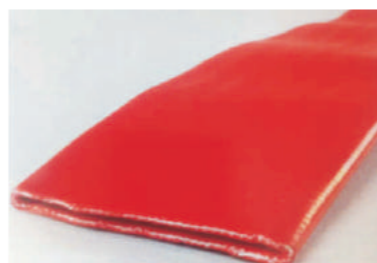

Inner Diameter (inch/mm)	Outside Diameter (inch/mm)	Working Pressure
1" 25	1.22" 1.7	8bar
1-1/2" 38	1.77" 1.9	8bar
2" 51	2.32" 2	8bar
2-1/2" 64	2.87" 2.1	8bar
3" 76	3.35" 2.5	8bar
4" 102	4.49" 2.6	8bar
6" 152	6.46" 3.1	8bar

Manure transfer hose

Designed for Fish Suction and Transfer, heavy duty water suction and transfer and for trash pump.PVC tube and Sturdy clockwise PVC Helix with high tensile strength polyester yarn reinforcement. Temperature range -13°F to +140°F.



Inner Diameter (inch/mm)	Outside Diameter (inch/mm)	Working Pressure
1-1/2" 38.1	2.03 51.56	7.58bar
2" 50.8	2.6 66.04	6.89bar
2-1/2" 63.5	3.01 76.45	6.89bar
3" 76.2	3.7 93.98	6.89bar
4" 101.6	4.78 121.41	5.52bar
6" 152.4	7.17 182.12	4.83bar
8" 203.2	9.34 237.24	4.14bar
10" 254	11.63 295.4	2.76bar

Designed for use in industrial washdown , irrigation and general dewatering ,pump discharge and drainage. Tube and Cover are PVC/NBR compound.Temperature range -36°F to +178°F.

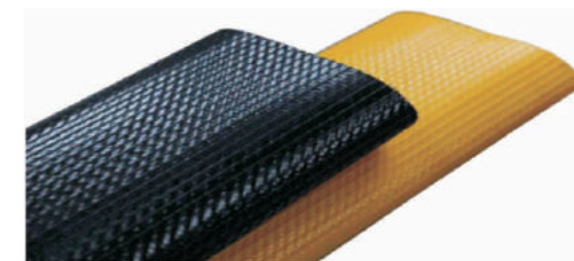

Inner Diameter (inch/mm)	Wall thickness (inch/mm)	Working Pressure
1-1/2" 38.1	0.11 2.791	7.25bar
2" 50.8	0.11 2.791	7.25bar
2-1/2" 63.5	0.11 2.791	7.25bar
3" 76.2	0.11 2.791	7.25bar
4" 101.6	0.11 2.791	3.79bar
6" 152.4	0.11 2.79	10.35bar
8" 203.2	0.11 2.79	10.35bar
10" 254	0.16 4.06	10.35bar

Heavy duty fertilizer or water suction transfer hose. Suitable for agricultural chemicals . Rated for full vacuum

Inner Diameter (inch/mm)	Outside Diameter (inch/mm)	Working Pressure
1-1/2" 38.1	1.89" 48	10bar
2" 50.8	2.44" 62	10bar
3" 76.2	3.46" 88	10bar
4" 101.6	4.49" 114	5.17bar



Designed for manure supply line. Suitable for manure supply ,also can be used for dewatering in mining and water transferring in harsh environment. Inner tube and cover are smooth PU, reinforcement with Circular woven polyester jacket .Temperature range -60°F to +176°F.

Inner Diameter (inch/mm)	Wall thickness (inch/mm)	Working Pressure
6" 154	0.17 4.2	14bar
7" 178	0.17 4.2	15bar
8" 204	0.175 4.5	15bar
10" 254	0.18 4.6	14bar

